

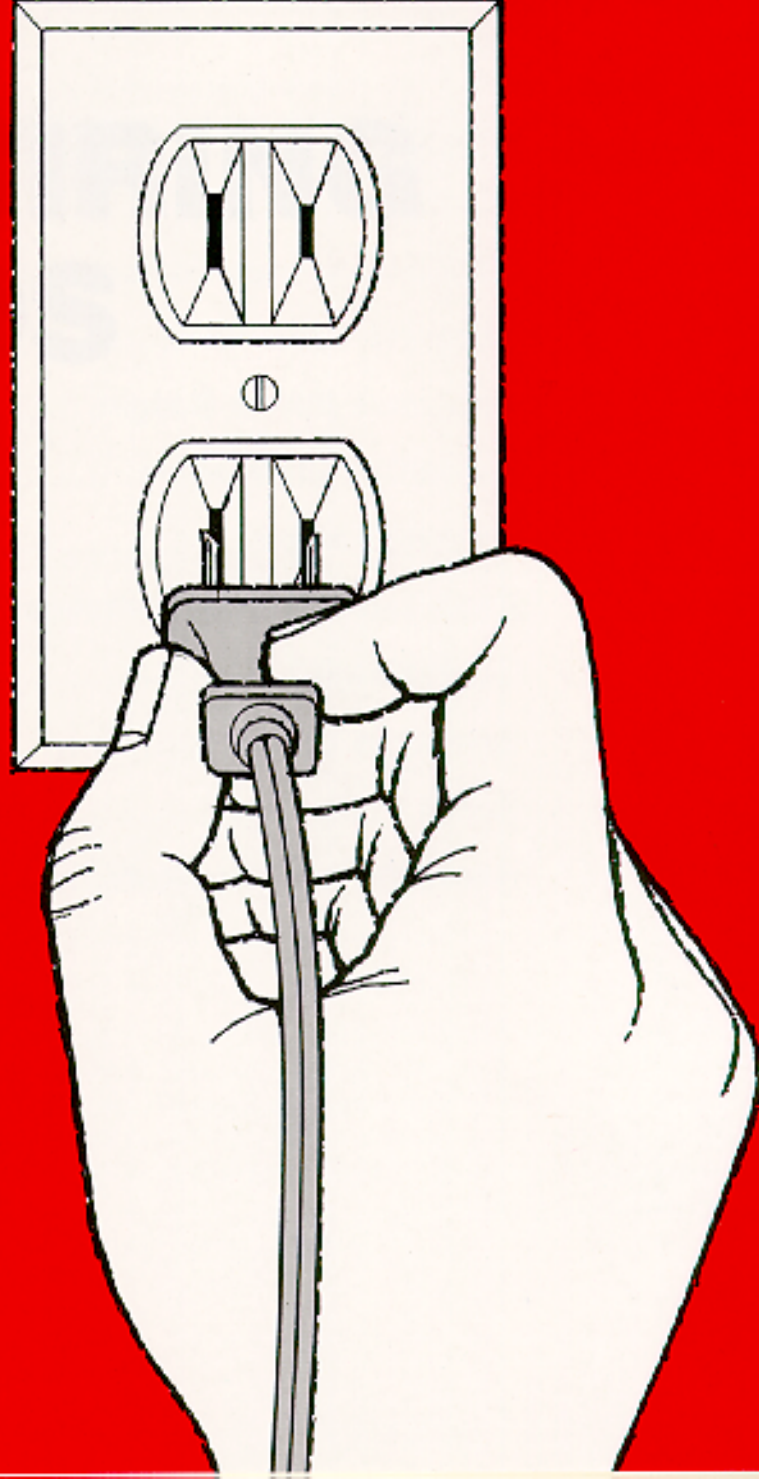

CPSC GUIDE TO

HOME WIRING HAZARDS

U.S. CONSUMER PRODUCT SAFETY COMMISSION • WASHINGTON, D.C. 20207



CPSC GUIDE TO
HOME WIRING
HAZARDS

This guide describes warnings of potential hazards. Each part of the home electrical system is listed along with warning signs that may indicate current or future problems. Each section describes problems and tells you what to do

CONTENTS

Overview	1
Warnings	5
Electrical Service Equipment	6
Electrical Panel Box	9
Appliance Power Budget	11
Fuses/Circuit Breakers	13
Lighting/Lamps	17
Receptacle Outlets/Switches	19
Cords/Plugs	25
Extension Cords	29
Shock Protectors	34
Home Wiring Protectors	36

OVERVIEW

The Consumer Product Safety Commission (CPSC) estimates that there are about 46 000 fires involving the home electrical distribution system each year. These fires result in 440 deaths, 1,420 injuries and \$434 million in property losses. It is estimated that there are approximately 760 electrocutions from all causes each year. Of these electrocutions, 310 involve consumer products (based on National Center for Health Statistics data).

This Guide to Home Wiring Hazards was written to help you find electrical dangers in your home before they cause fires or electrical shock. It provides guidance for pinpointing the locations of problems within your electrical system before you seek professional assistance. It can also help you avoid potential problems.

This booklet is **not** an instruction manual for repairing defective electrical systems. Finding specific defects in electrical systems and repairing them are jobs for qualified electrical professionals. For your safety, have them make an assessment of the problems and carry out the repairs needed to assure the electrical safety of your home.

ELECTRICITY IS USEFUL BUT CAN BE DANGEROUS Your home electrical system provides energy to heat or cool your home cook drive power tools and perform many other useful functions However this same energy can start fires or cause electrical shock if problems with this system are ignored

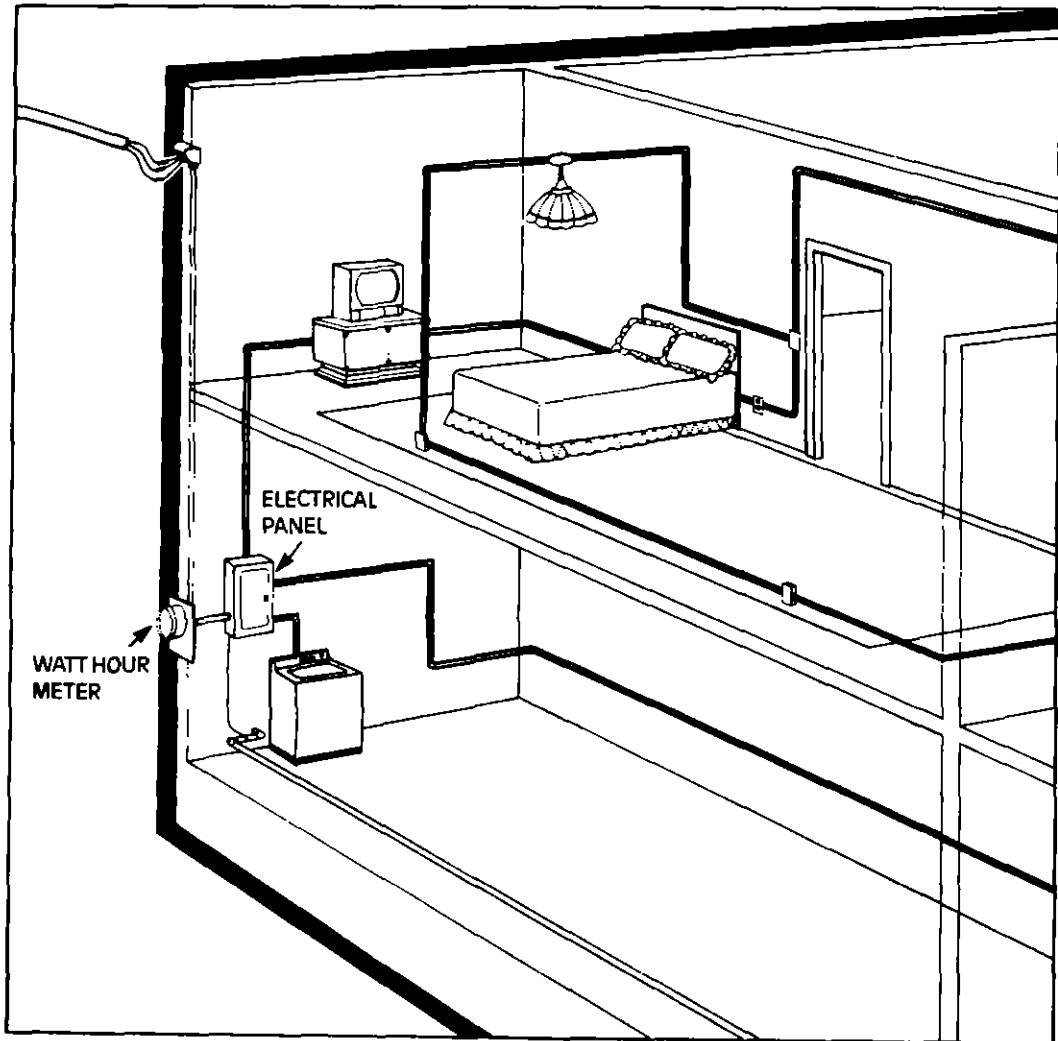

ELECTRICAL SYSTEMS WEAR OUT This system should not be taken for granted It ages and wears out the same as other parts of your home. This system can provide service and convenience provided that you check its condition regularly and have it improved and repaired when problems are found

HAVE YOUR ELECTRICAL SYSTEM INSPECTED Consumer Product Safety Commission studies of residential electrical fires show that the majority of serious fires need not have occurred. The conditions that caused the fires probably would have been detected by an electrical inspection. These problems were not detected or corrected because no inspection had been made for several years. In a number of cases investigated by CPSC homes ranging from 40 to 100 years old had not been inspected since they were built. A safety inspection should be performed by a qualified electrician or licensed electrical inspector.

To insure the electrical safety of your home your electrical inspection should be up to date and defects corrected. There are no hard and fast rules about frequency of inspection but here are some suggestions.

To determine when your electrical system was last inspected, examine the door and cover of your electrical panel(s). The panel should contain a label or tag with a date, a signature, or initials on it. If there is more than one date, the most recent one should be the date of the last inspection. **DO NOT** remove the service-panel cover. This is a job for a qualified electrician.

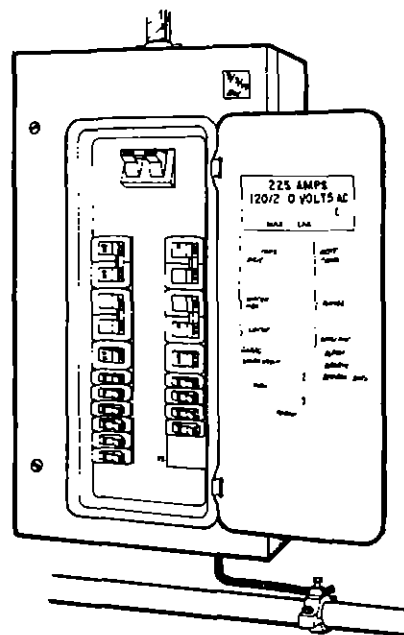

**CIRCUIT BREAKER
PANEL**

If your last inspection was—

- 40 or more years ago inspection is overdue.
- 10–40 years ago inspection is advisable especially if substantial electrical loads (high wattage appliances, lights and receptacle outlets or extension cords) have been added or if some of the warning signs discussed in the next section are present.
- Less than 10 years ago inspection should not be needed, unless some of the warning signs, described in the next section, are present or temporary wiring has been added.

You may live in an area that is not served by state or local electrical inspectors so that no record will be found on your electrical panel. In that case, use the age of the house as a guide to the probable need for an inspection.

HAVE DEFECTS FIXED If an electrical professional identifies dangerous defects in your electrical system, have changes or repairs made promptly. At the same time, have him inspect the wiring system for other problems.

INSTALL SMOKE DETECTORS The most important thing you can do to prevent home fire deaths is to have operating smoke detectors installed to warn people if a fire starts.

Fires in the home are most dangerous at night when people are sleeping. Be sure that you have alarms that guard escape routes and can be heard in bedrooms. Your local building inspector or fire department can provide additional information on protecting your home with smoke detectors. Test them every month and keep spare batteries on hand.

PRACTICE ESCAPING Plan the emergency escape routes for your family. Practice using them until everyone knows what to do in case a fire occurs. Don't forget that upper-story bedrooms may require fire escapes or chain ladders to permit escape if normal routes are blocked by fire.

WARNINGS OF POTENTIAL HAZARDS

- POWER OUTAGES** – fuses need replacement or circuit breakers need resetting frequently
- OVERRATED PANEL** – electrical panel contains fuses or circuit breakers rated at higher currents than the ampacity (current capacity) of their branch circuits sometimes called overamped or overfused
- DIM/FLICKERING LIGHTS** – lights dim or the size of your television picture shrinks often
- ARCS/SPARKS** – bright light flashes or showers of sparks anywhere in your electrical system
- SIZZLES/BUZZES** – unusual sounds from the electrical system
- OVERHEATING** – parts of your electrical system such as switch plates receptacle outlet covers cords and plugs may be warm but should never be hot—painful to touch or discolored from heat
- ODORS** – burned or overheated wires often give off an odor of hot insulation
- PERMANENTLY INSTALLED EXTENSION CORDS** – used to extend the home wiring system for a long period instead of being used temporarily to connect some appliance with a cord too short to reach the receptacle outlet
- LOOSE PLUGS** – attachment plugs that wobble or pull out of a receptacle easily
- DAMAGED INSULATION** – cut, broken or cracked insulation
- ELECTRICAL SHOCKS** – any shock even a mild tingle, may be a warning of danger—electrocution

ELECTRIC SERVICE EQUIPMENT

Warnings Arcs/Sparks, Dim/Flickering Lights

Electric service equipment carries electric power from the electric company's lines to your home's electrical panel. In a typical above-ground installation, the 'service drop' connects the low voltage (120/240 volts) utility lines to the service entrance cable.

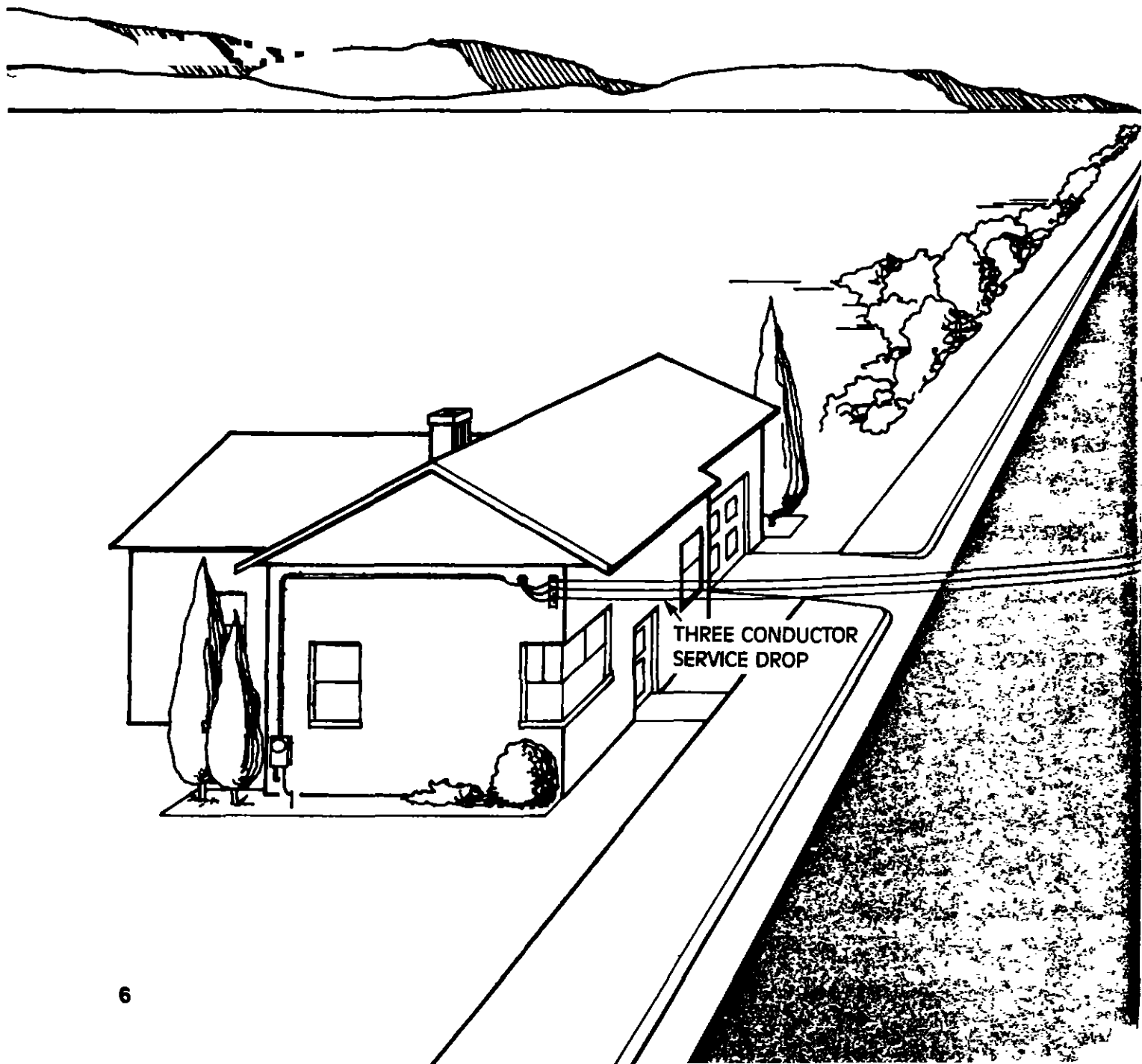

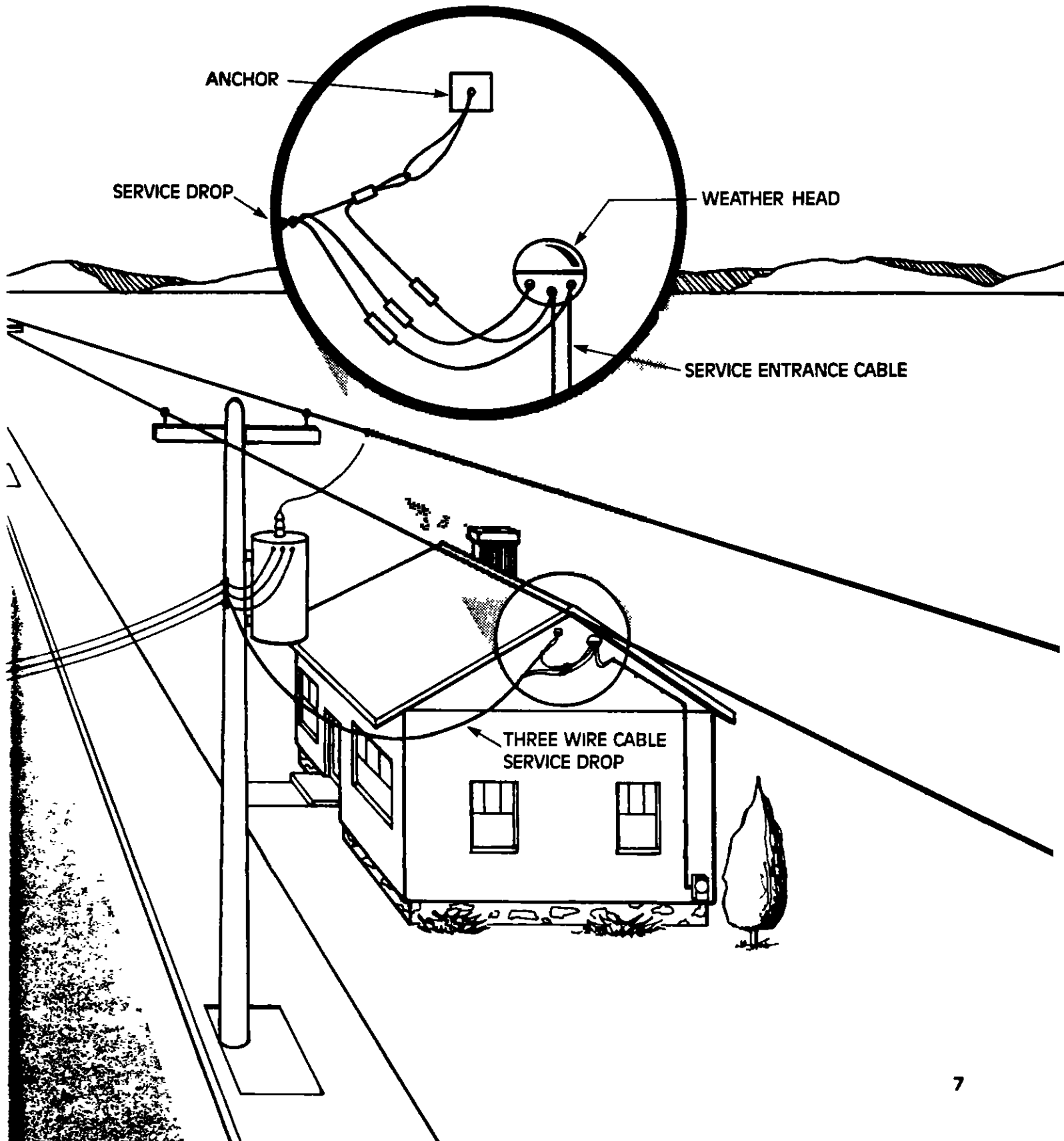
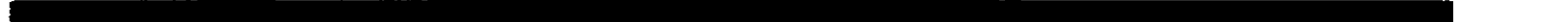

PROBLEM Arcing or sparking can occur anywhere in this system. Rubbing between parts of the house or trees and the electric service equipment can cause damage that leads to sparking.

WHAT TO DO:

Do not attempt to correct the problem yourself or touch any of the equipment. Call the electric power company immediately. They or emergency personnel such as firemen are the only ones authorized to turn off the power in this part of your electrical system.

PROBLEM Flickering of your home lights and variation of the size of your TV picture when the wind blows can be caused by bad contacts at the junction of the service entrance cable and the service drop.

WHAT TO DO:

Do not attempt to correct the problem yourself or touch any of the equipment. Call the electric power company immediately.

ELECTRICAL PANEL/BOX

Warnings Sizzles/Buzzes, Overheating, Odors, Power Outages

Electrical power enters the home through the electrical panel. A service entrance cable carries electrical power from the meter to this panel. In multi-family dwellings, electrical power is distributed from the building panel to dwelling unit panels. Single-family dwelling panels distribute electricity to the branch circuits.

Branch circuits provide electricity to receptacle outlets, lights, and appliances throughout the home. They are fed by the wires coming from the electrical panel.

An electrical panel may contain fuses or circuit breakers, or both. Fuses and circuit breakers, with proper current ratings, protect branch circuits from potential fire hazards. When used at the proper current ratings, they disconnect electric current when it exceeds the safe level for each branch circuit. This is usually referred to as opening a fuse or a circuit breaker (blowing or tripping).

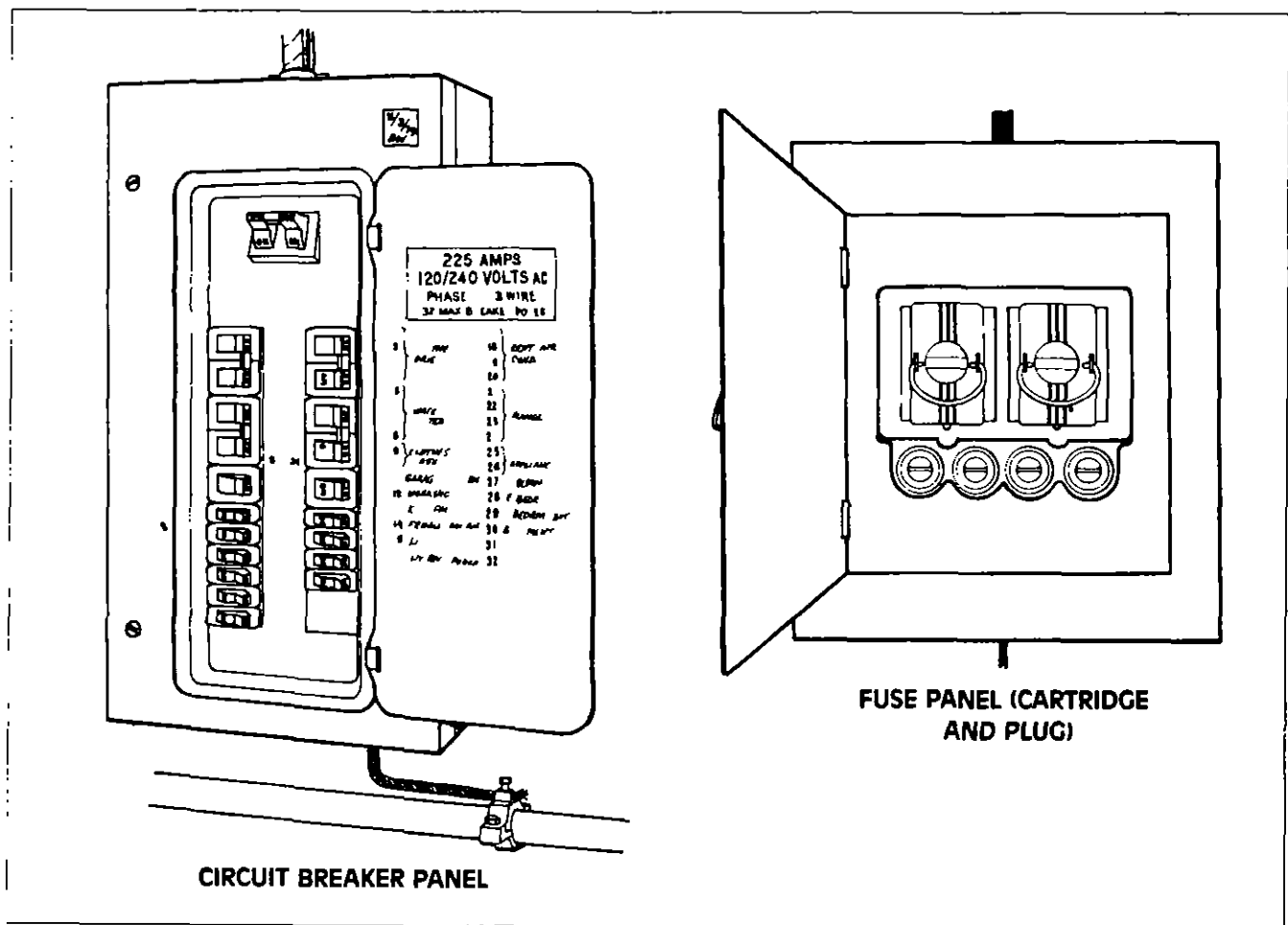

Many electrical panels also have main fuses or circuit breakers that can disconnect power from the entire home or from some group of branch circuits.

PROBLEM Power may be out on one branch circuit because too many appliances are connected

WHAT TO DO:

Before replacing the fuse or reclosing the circuit breaker check to see which fuse or circuit breaker is blown or tripped and which appliances are without power

Find the power (watts) ratings of these appliances on their ratings labels and add up the total (see APPLIANCE POWER BUDGET on page 11) The total wattage on a branch circuit at one time should be less than 1500 or 2000 as called for on the Appliance Power Budget page 11

If total watts in use exceed the amount allowed on that branch move an appliance from the overloaded branch to another branch circuit with fewer appliances. If this is not possible, get help from a qualified electrician

Once the overload condition is corrected replace the burned-out fuse with a 15 ampere one (unless you are certain that the branch circuit is wired for 20 amperes) or reclose the circuit breaker

Above all never put anything other than a fuse in a fuse holder

APPLIANCE POWER BUDGET

15 ampere branch circuit can carry 1500 watts*
 20 ampere branch circuit can carry 2000 watts

Find nameplate  with power (watts) rating

Add up total watts for appliances that you may use at the same time on the same branch circuit

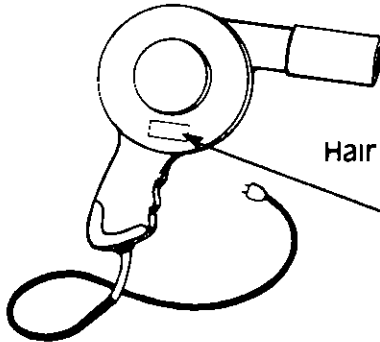

Hair Dryer

1400 watts
 + 1000 watts

 2400 watts

too much for
 15 A or 20 A

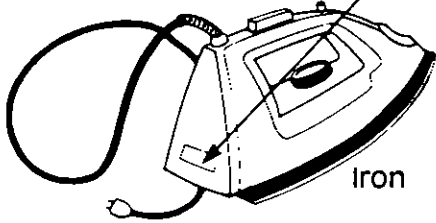

Iron

Portable Heater

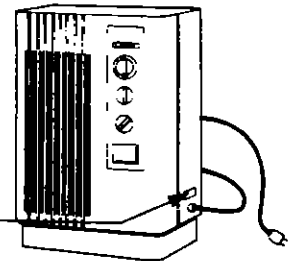

1200 watts
 + 600 watts

 1800 watts

OK for 20 A
 too much for 15 A

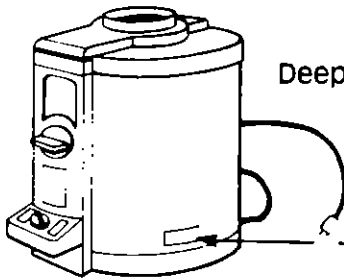

Deep Fat Fryer

1300 watts
 + 150 watts

 1450 watts

OK for
 20 A or 15 A

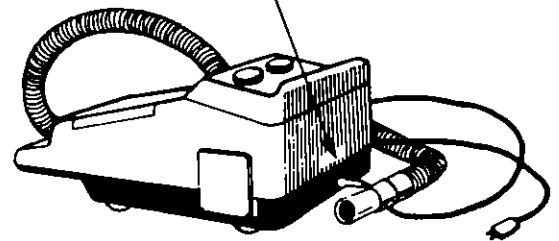

Vacuum Cleaner

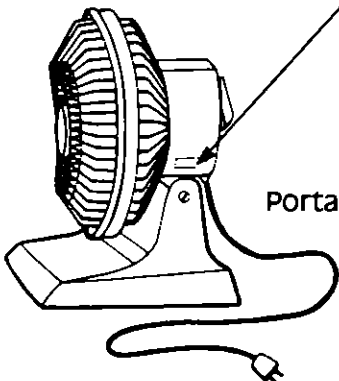

Portable Fan

* Most home lighting and receptacle outlet branch circuits may carry as much as 1500 watts (15 ampere branch) some kitchen circuits as much as 2000 watts (20 ampere)

PROBLEM One appliance repeatedly blows fuse or trips a circuit breaker indicating an appliance defect that could cause a fire or shock hazard

WHAT TO DO:

Obtain help from a qualified appliance repairman or replace the appliance which may be faulty

PROBLEM Fuse blows or circuit breaker trips when a particular switch light or receptacle outlet is used

WHAT TO DO:

Obtain help from a qualified electrician Do not put in a higher ampere fuse or circuit breaker

FUSES/CIRCUIT BREAKERS

Warning Overtaxed panel

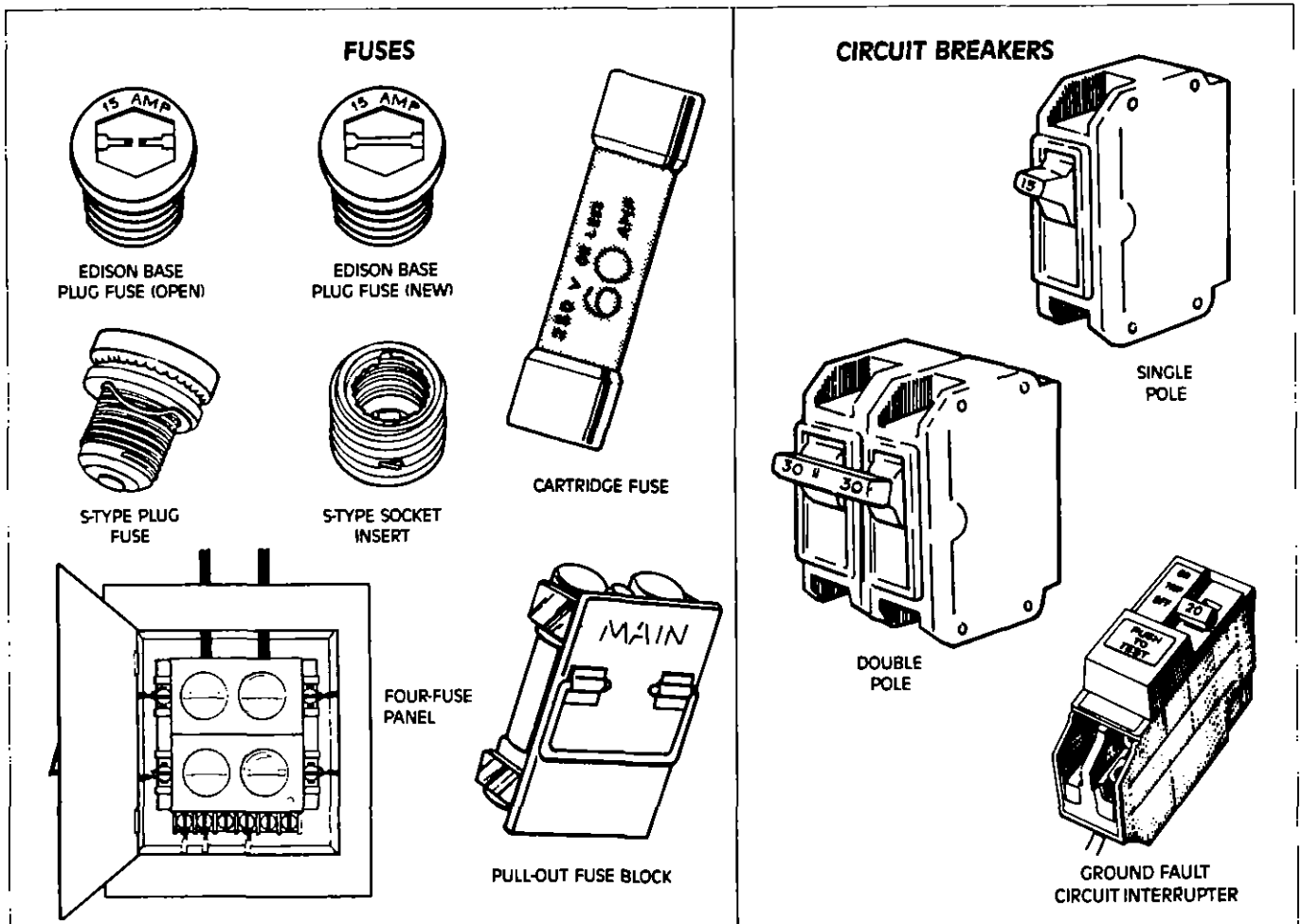

Fuses and circuit breakers are safety devices located on your electrical panel to prevent over loading and fires. They stop the electrical current if it exceeds the safe level for some portion of the home electrical system. Overloading means that the appliances and lighting in the home regularly demand more electrical current than the home electrical system can safely deliver.

If the demand for electrical current exceeds the safe level, a fuse opens once and must be replaced to reconnect the circuit. A circuit breaker trips its switch to open the circuit, and the circuit is reconnected by closing the switch manually.

There are at least two different types of circuit breakers. One has a control handle that swings all the way to OFF when it is tripped. The other has an intermediate position close to ON (sometimes it is difficult to see that it has tripped).

Both types of circuit breakers must be reset with the hand control after the problem has been eliminated. The first type should simply be moved back to ON, the second moved first to OFF and then to ON.

PROBLEM If your home has a four fuse panel (60-ampere) service, most of the fuses should be rated at 15 or at most 20 amperes. If it has one or more fuses rated above 20 amperes someone may have tried to avoid power outages by substituting higher amperage fuses. Your wiring may be exposed to overloading that can lead to fire.

WHAT TO DO:

Reduce the fuses to 15 ampere rated ones unless you are absolutely certain that a special circuit is wired for 20 amperes.

If fuses continue to blow keep track of which branch circuits are affected and which appliances are in use when the power outage occurs. Consult a qualified electrician to resolve the problem.

At least, have your electrical panel inspected to determine which branches should be protected at a 15 ampere level and which, if any, are adequate for 20 ampere safety devices.

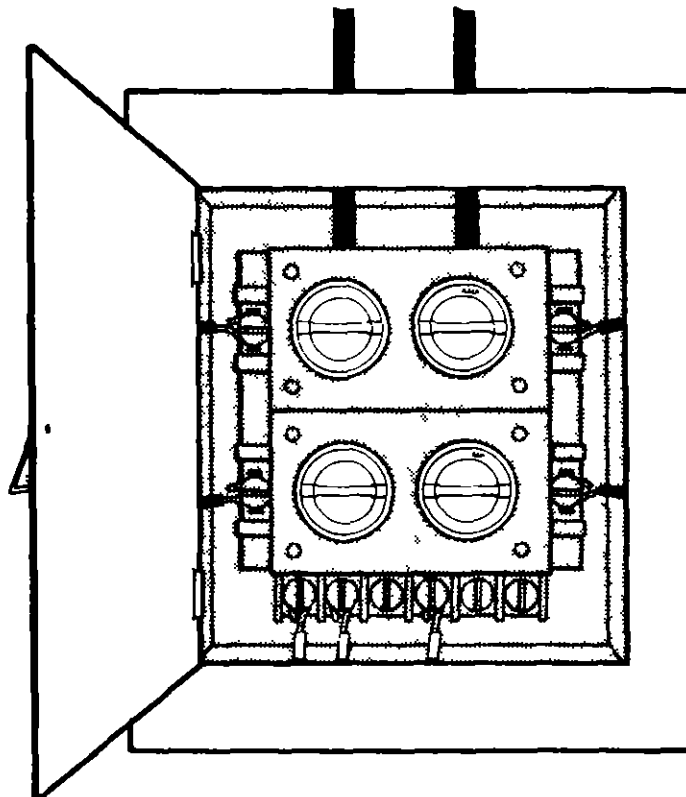

**FOUR FUSE
PANEL**

PROBLEM Your fuse panel has Edison base plug fuses (screw base like a light bulb) installed. Fuses of different ratings will fit in Edison sockets.

Consumers sometimes replace a fuse that repeatedly blows with a higher ampere rated fuse. Although the new fuse may not open, it also may not protect the branch circuit. Overloading that leads to fire can occur.

WHAT TO DO:

To prevent future installation of fuses that allow currents too high for your wiring, your fuse panel should be converted to S type sockets that accept only fuses of the correct amperage rating. If you have Edison base fuse sockets, have them fitted with the S type socket inserts.

EDISON BASE/S TYPE FUSES

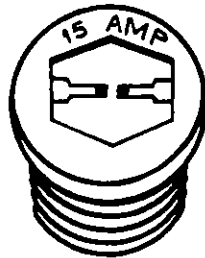

EDISON BASE
PLUG FUSE (OPEN)

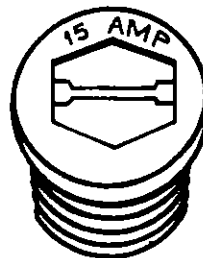

EDISON BASE
PLUG FUSE (NEW)

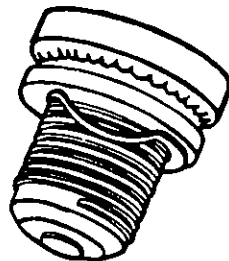

S TYPE PLUG
FUSE

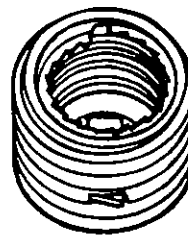

S TYPE SOCKET
INSERT

PROBLEM Your electrical panel has 25 ampere or higher rated fuses or circuit breakers installed that control 15 or 20-ampere rated lighting and receptacle outlet circuits. These overrated devices allow overloading of your branch circuits that can lead to fire.

WHAT TO DO:

Reduce the lighting and receptacle outlet branch circuit safety devices to 15 amperes unless you are certain that a special circuit is wired for 20 amperes.

If fuses continue to blow keep track of which branch circuits are affected and which appliances are in use when the power outage occurs. Consult a qualified electrician to resolve the problem.

At least have your electrical panel inspected to determine which branches should be protected at a 15 ampere level and which, if any, are adequate for 20 ampere fuses or breakers.

LIGHTING/LAMPS

Warnings Dim/Flickering Lights, Sizzles/Buzzes

This section concerns home wall and ceiling mounted surface and recessed lighting

Illustration (A)

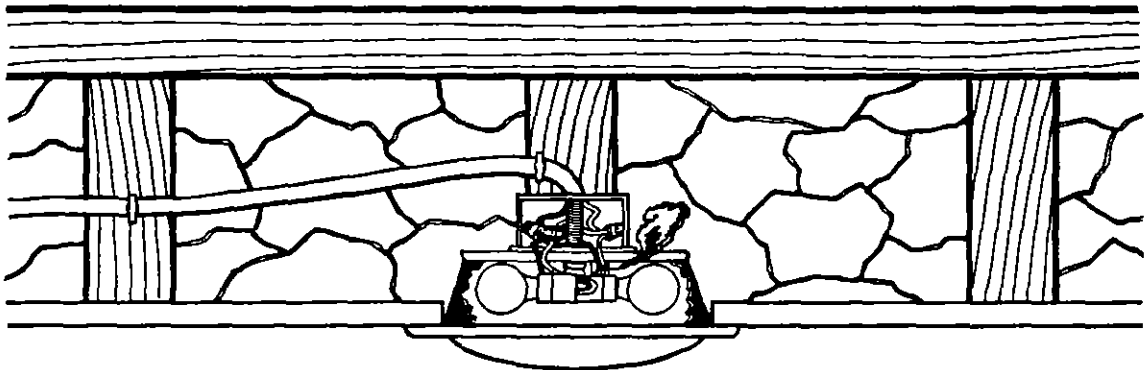
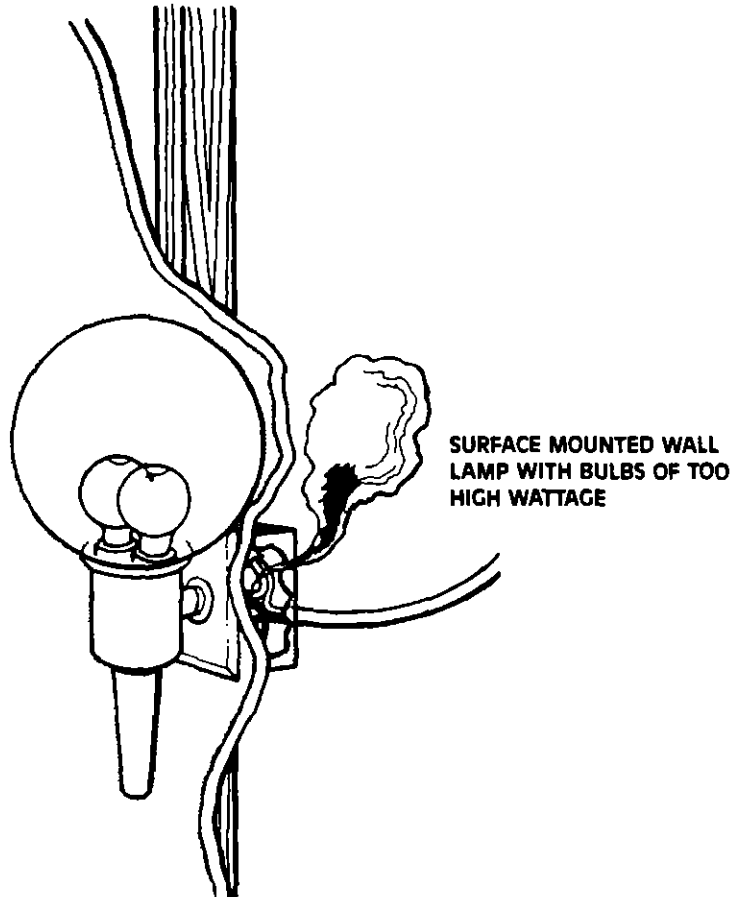

Illustration (B)

PROBLEM Lamp bulbs of too high wattage are used and cause overheating of the lamp insulation

WHAT TO DO:

Turn off the light fixture. Do not use until a qualified electrician has corrected the problem

In other light fixtures check the bulbs that you are using. Do they have the correct power ratings (watts) called for on the lighting fixtures? Older fixtures may not state what the number of watts should be. Sixty watt bulbs are usually used with older fixtures

See illustration (A)
on the preceding page

PROBLEM Arcing, buzzing, odors, or discoloration of lamp parts signal overheating caused by filling the space over the fixture with heat insulation such as fiberglass or cellulose. Most lighting fixtures are designed and rated to operate safely in open spaces

WHAT TO DO:

Turn off the light fixture immediately. Have a qualified electrician determine if heat insulation has been added around the recessed light fixture after it was installed.

The electrician may advise you that some insulation around the original fixture needs to be removed or that a fixture that can be used with insulation needs to be installed.

Recessed light fixtures are now provided with a device that interrupts electrical power to the fixture when it overheats for any reason.

See illustration (B)
on the preceding page

RECEPTACLE OUTLETS/SWITCHES

Warnings Shock, Power Outage, Overheating, Arcs/Sparks

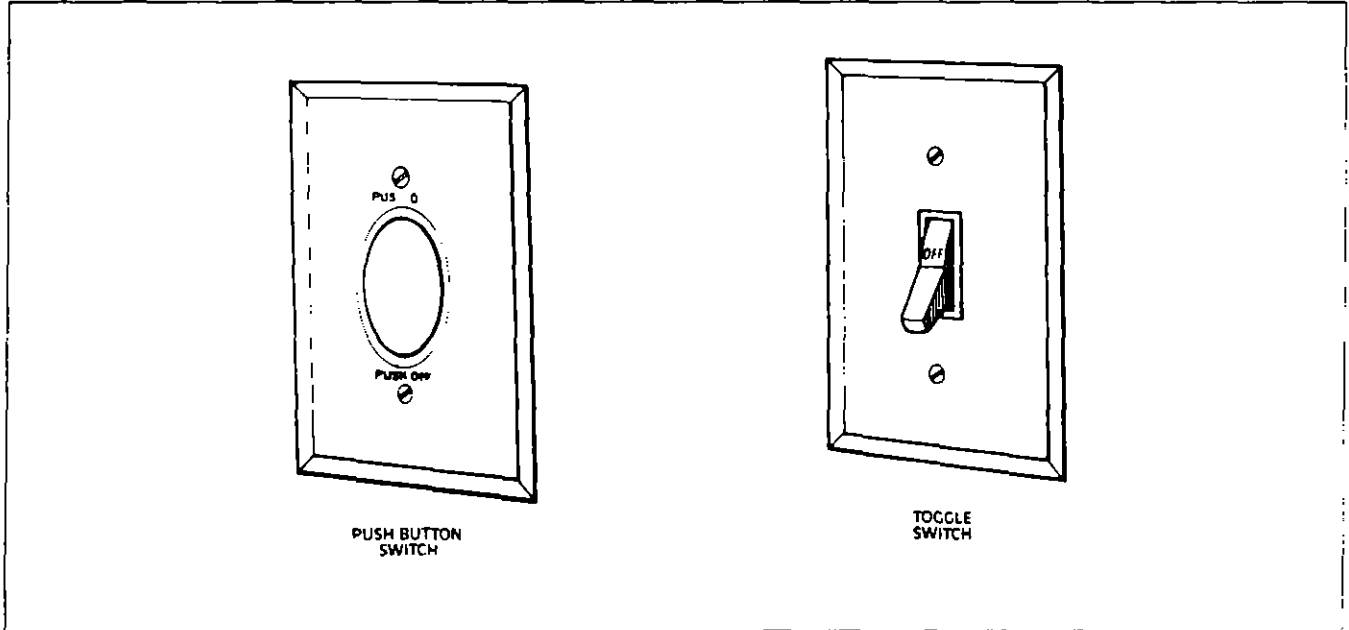

Switches are used to turn the power on and off. Receptacle outlets are usually mounted on a wall or floor to supply electricity to appliances through a cord and plug.

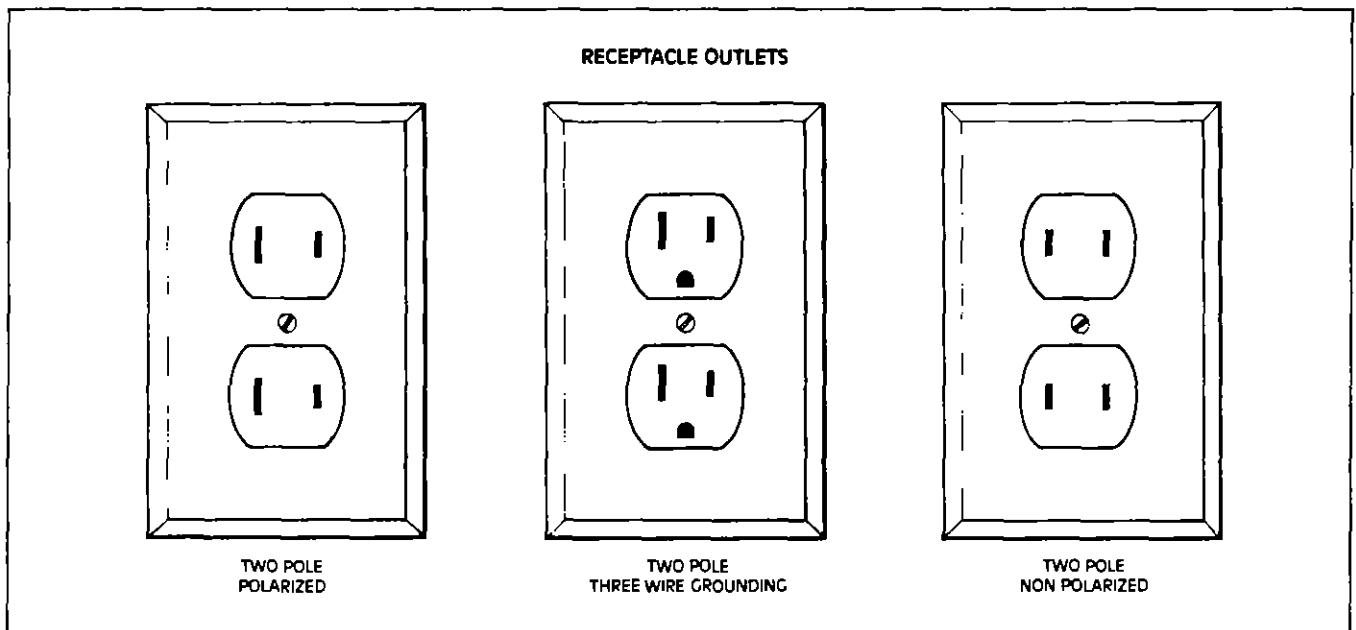

PROBLEM You get a shock when you touch a metal faceplate or metal screws of a receptacle outlet or switch

WHAT TO DO:

Turn off the branch circuit at the electrical panel unless it affects an essential appliance.

Avoid touching the faceplate or using the device until you get help from a qualified electrician

PROBLEM You get a shock when you touch the outer shell of an electric lamp socket.

WHAT TO DO:

Unplug the lamp

Check the receptacle outlet and the plug of the lamp cord to be sure that they are polarized (one blade wider than the other) If not, they should be replaced with polarized ones (as well as any other unpolarized plugs or receptacle outlets in your home) by a qualified electrician

If the lamp plug is polarized and you received a shock, either the lamp or your receptacle outlet is miswired. The problem should be identified and corrected by a qualified electrician

PROBLEM When you use a particular receptacle outlet or switch, the fuse blows or the circuit breaker trips.

WHAT TO DO:

Do not put in a higher ampere fuse or circuit breaker. Obtain the help of a qualified electrician to correct the problem.

PROBLEM Faceplates of switches or receptacle outlets in use feel hot—uncomfortable to touch. Unused receptacle outlets may also feel hot because the electric power delivered to one receptacle outlet often passes through the connections of one or more other receptacle outlets. This indicates a potential fire hazard in the receptacle outlet, switch, or wiring.

WHAT TO DO:

Discontinue use of the hot receptacle outlet or switch immediately. Obtain help from a qualified electrician as soon as possible.

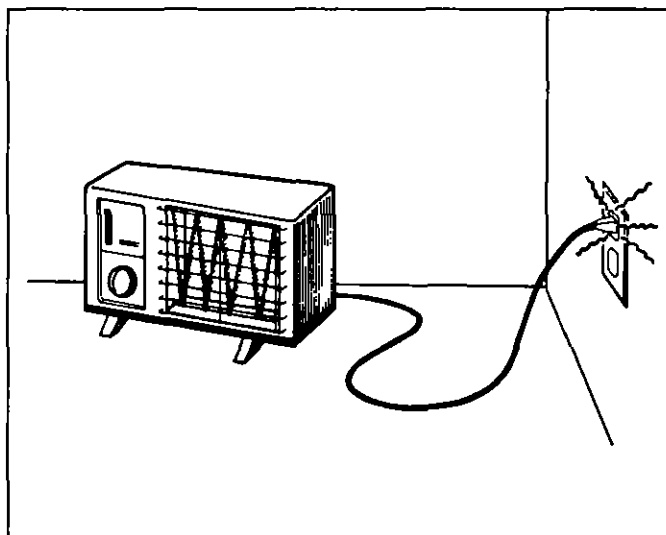

PROBLEM If an appliance plug slips in and out of receptacle outlets easily or tends to pull out from the weight of the cord the electrical connection may be loose and likely to overheat.

WHAT TO DO:

Insert plugs (preferably new ones) from two or three other cords. If all or most of them fit firmly, the first appliance cord is worn out or defective.

Do not bend the blades of a plug because this usually causes worse overheating later

The receptacle outlet probably needs to be replaced by a qualified electrician if most of the plugs fit loosely

PROBLEM Aluminum wires connected to receptacle outlets and switches. These connections tend to loosen during use lose good electrical contact and overheat.

WHAT TO DO:

Contact a qualified electrician to determine a reliable way of repairing aluminum wiring

PROBLEM Newer homes may have back wire push in wire connections to receptacle outlets and switches rather than connections made by tightening a metal screw down on a loop of the wire. These connections may tend to loosen and overheat

WHAT TO DO:

If you know that you have back wire push in connections feel your receptacle outlet and switch faceplates regularly for overheating. If you detect this consult a qualified electrician.

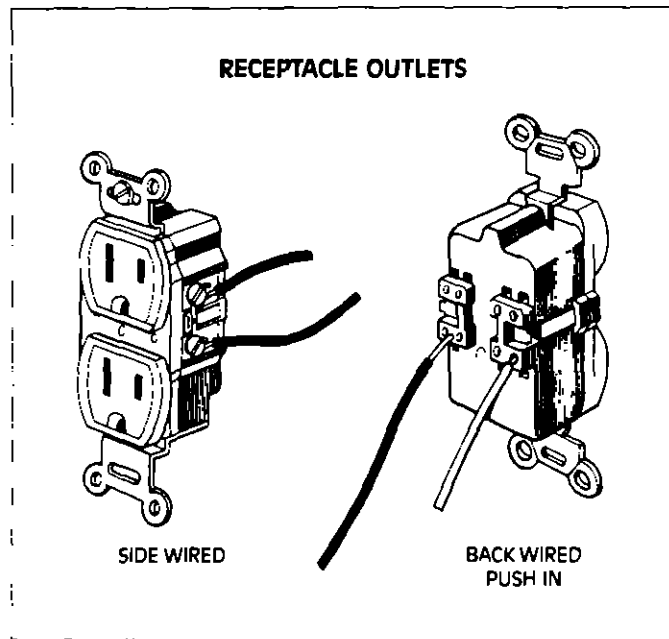

PROBLEM Operation of a switch causes visible arcing or sparking

WHAT TO DO:

The switch should be checked by a qualified electrician.

PROBLEM Removal of plug from receptacle outlet causes visible arcing or sparking. This usually means that there is electrical current flowing through the plug when you remove it.

WHAT TO DO:

If possible, turn off appliances by using their switch before unplugging them. Avoid using the plug to turn appliances off because this can damage the plug and the receptacle outlet. If the faceplate feels hot, consult a qualified electrician.

PROBLEM Missing faceplates expose electrical parts of receptacle outlets and switches, creating a potential shock hazard.

WHAT TO DO:

Obtain the type of faceplate that fits the particular receptacle outlet or switch and replace the missing cover.

PROBLEM Switches or receptacle outlets do not work.

WHAT TO DO:

Failure to operate should not be ignored. Obtain the help of a qualified electrician. The failure may not seem dangerous in itself, but it can be a warning sign of a more serious problem.

CORDS/PLUGS

Warnings Damaged Insulation, Arcs/Sparks, Overheating

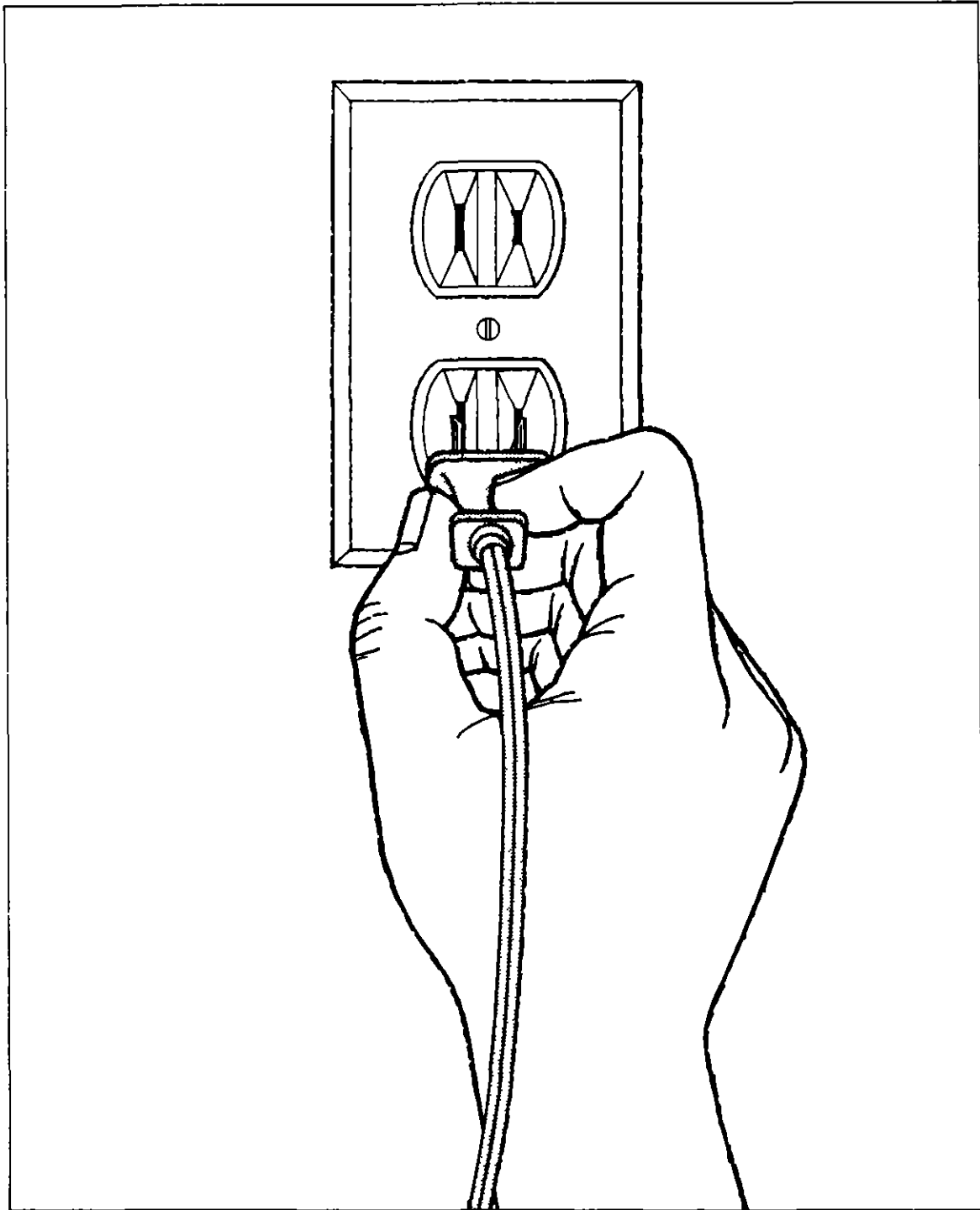

An appliance cord connects an appliance to a receptacle outlet. Two wire cords connect to the hot and neutral connections of the power supply. Three wire cords have an additional conductor to connect to ground as a safety measure.

PROBLEM Insulation is damaged (cut crushed melted hardened cracked etc) exposing the wire and presenting a shock or fire hazard

WHAT TO DO:

Unplug the appliance. Do not use it until the cord can be replaced. Have a qualified repair shop replace the cord with the proper one for the appliance.

PROBLEM Sparking and/or smoking occurs close to the plug when the cord is used to pull it out of the receptacle outlet

WHAT TO DO:

Do not pull on the cord

Disconnect the appliance first by its switch if it has one. Remove the cord from the receptacle outlet by pulling on the plug. If the cord has been pulled out often or shows any signs of damage at the plug stop using the appliance. Have the cord or plug replaced by a qualified repairman

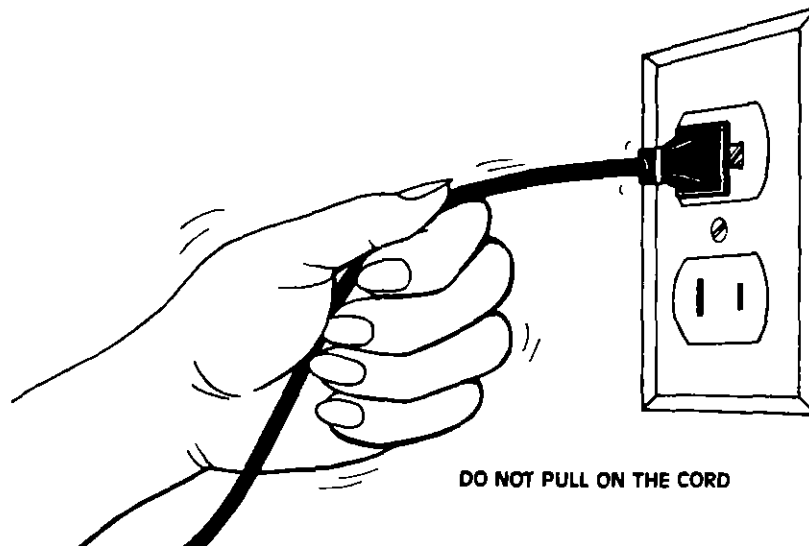

PROBLEM While a hand held appliance such as a hair dryer or electric drill is in use smoke or sparks come from the cord, near the body of the appliance or the plug. The appliance stops working.

WHAT TO DO:

Unplug the appliance. Replace the appliance or have the cord replaced by a qualified repairman. Never wrap the cord tightly around the appliance when you put it away. Arrange the cord with no sharp bends.

PROBLEM Overheating occurs in the plug of an appliance cord. The plug feels unusually warm or hot to touch. It may melt, smoke or give off odors.

WHAT TO DO:

Unplug and stop using the appliance. Have the appliance cord replaced by a qualified repairman.

Observe the performance of the new plug with full power on the appliance. If it still overheats, the receptacle outlet is probably worn or defective and should be replaced by a qualified electrician.

PROBLEM Cords may be improperly placed and become damaged This can cause overheating and fire.

WHAT TO DO:

Do not fasten cords in place with staples nails etc

Do not place cords permanently in high traffic floor areas or pinched in doorways

Do not cover cords with rugs carpets furniture, etc

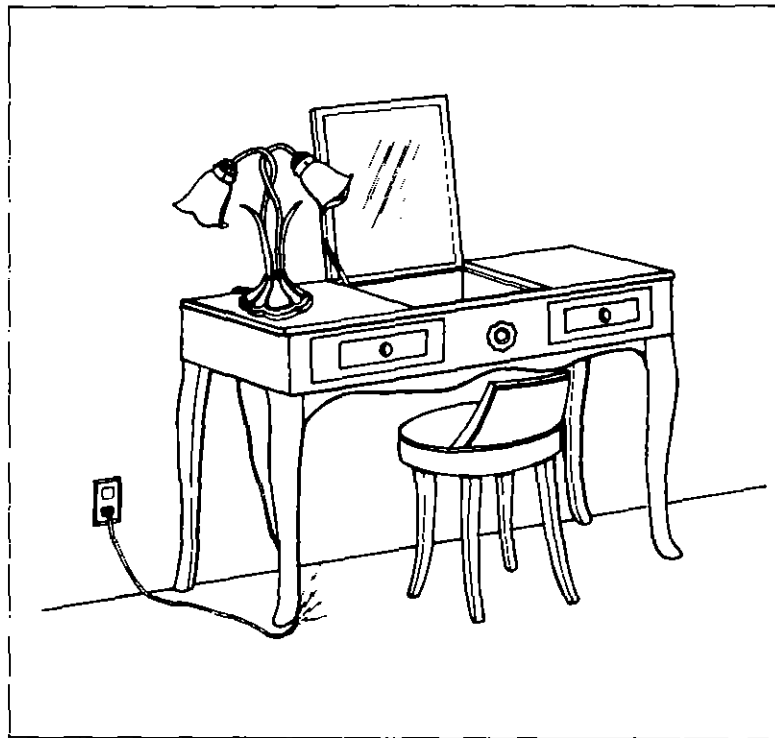

EXTENSION CORDS

Warnings Shocks, Overheating, Permanent Use

An extension cord is an electrical cord with an attachment plug at one end, and one or more receptacles at the other. They are available in two conductor (polarized no ground) and three conductor (polarized with grounding conductor) versions.

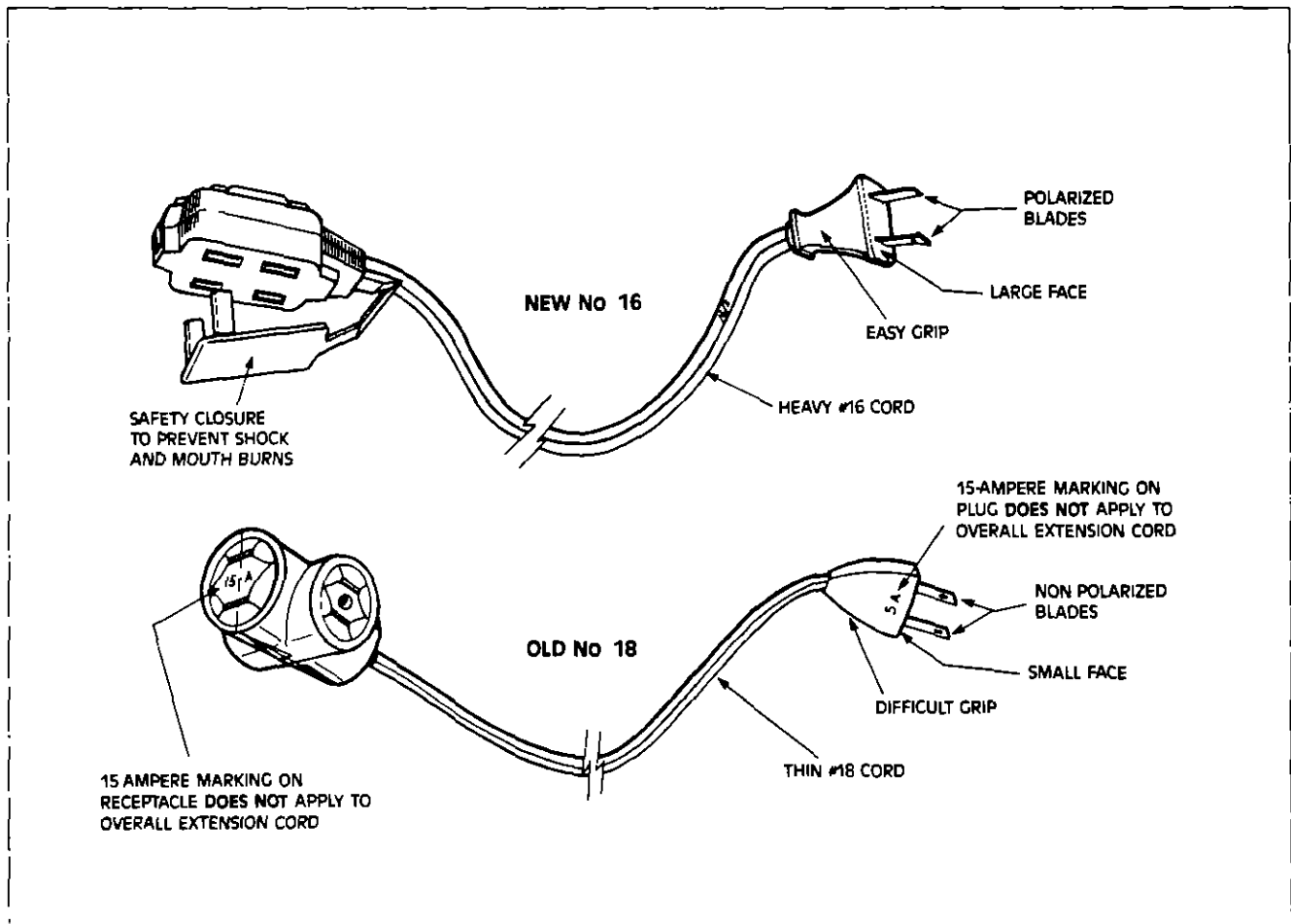

PROBLEMS Older extension cords with small plugs and without safety closures expose young children to shock hazards and mouth burn injuries. Young children can contact a live blade with a finger or tongue.

WHAT TO DO:

Replace the older extension cords with new cords that have large plugs and convenient finger grips large faces and safety closures for the receptacle end

PROBLEM Cords have dry and brittle insulation which can cause shock and burn injuries.

WHAT TO DO:

Get new cords to replace the ones that have damaged insulation

PROBLEM Older extension cords made with small (No 18 gauge) wire that overheat at 15 or 20 amperes

WHAT TO DO:

Replace with new extension cords having heavier No 16 gauge wire (the lower the gauge number, the heavier the wire and the more electrical current the cord can safely carry)

The difference between these cords is not obvious but the new No 16 cords usually have 16/2 or 16/3 stamped on the cord and will have the wire size printed on the package.

PROBLEM Some older small wire extension cords (No 18) that have 15 amperes (15-A) markings on the plugs and sockets. The 15-A markings were intended to apply only to the amount of electric current that the plugs and sockets could carry and not to the cords. These No 18 cords will overheat if they carry 15 amperes.

WHAT TO DO:

Replace these older extension cords.

PROBLEM Overheating of extension cords can occur at the plug at the socket or over the entire length of the cord. Hot plugs and sockets are caused by deteriorated connections to the cord wires. Overheating of the entire cord is usually caused by overloading (connecting appliances that need too many watts for the wire size of the cord)

WHAT TO DO:

Feel the cords when they are in use. If hot, disconnect the appliance(s)

Replace extension cords. Be sure that the total number of watts connected to the extension cord are no more than the new cord rating

Refer to the Appliance Power Budget for how to determine wattage of the appliances.

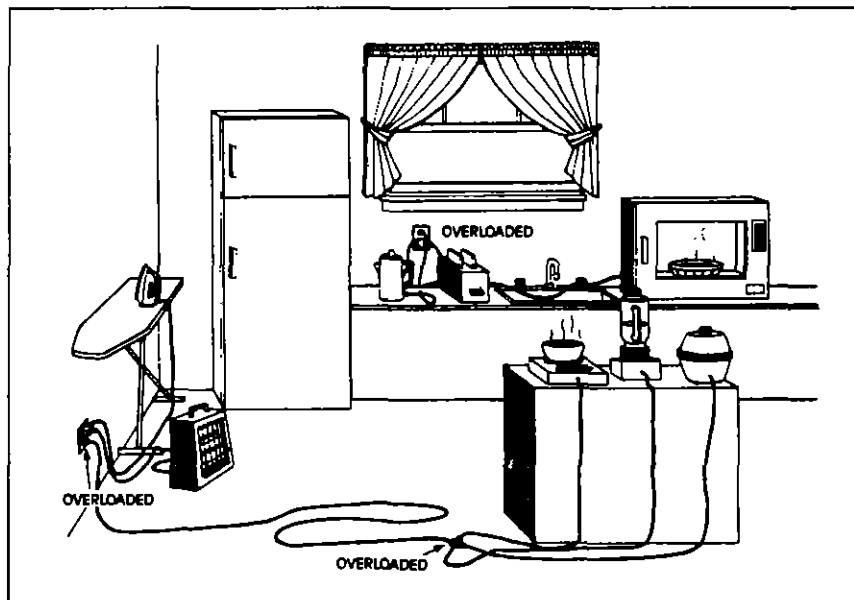

PROBLEM Extension cords are installed instead of permanent wiring to provide more receptacle outlets for your home system

WHAT TO DO:

Extension cords are intended only for short term use. Discontinue use of the extension cords. Get a qualified electrician to install permanent wiring to extend your home system

PROBLEM Extension cords have been repaired or joined by means of weak or exposed wire splices.

WHAT TO DO:

Replace these patched cords with new ones. Destructive fires have been caused by home-made splices.

PROBLEM Extension cords may be improperly placed to pinch or bend the cord and damage its insulation or wires. This can cause overheating and fire.

WHAT TO DO:

Do not fasten cords in place with staples nails etc.

Do not place cords permanently in high traffic floor areas or pinched in doorways.

Do not cover cords with rugs carpets furniture etc.

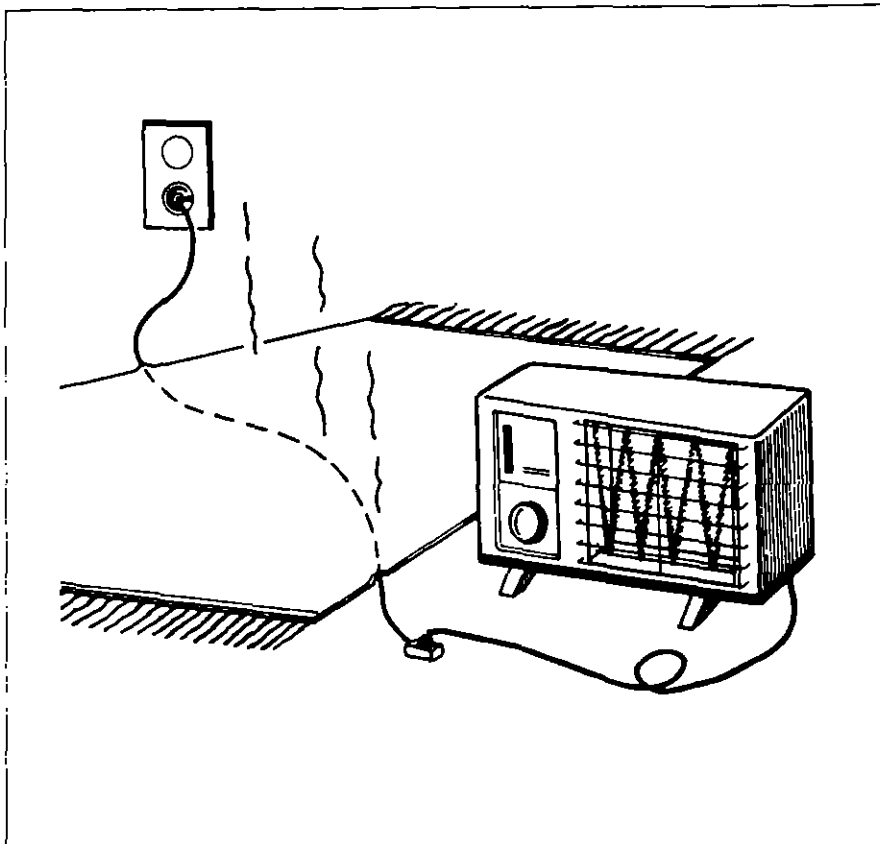

SHOCK PROTECTORS

Warning Shock

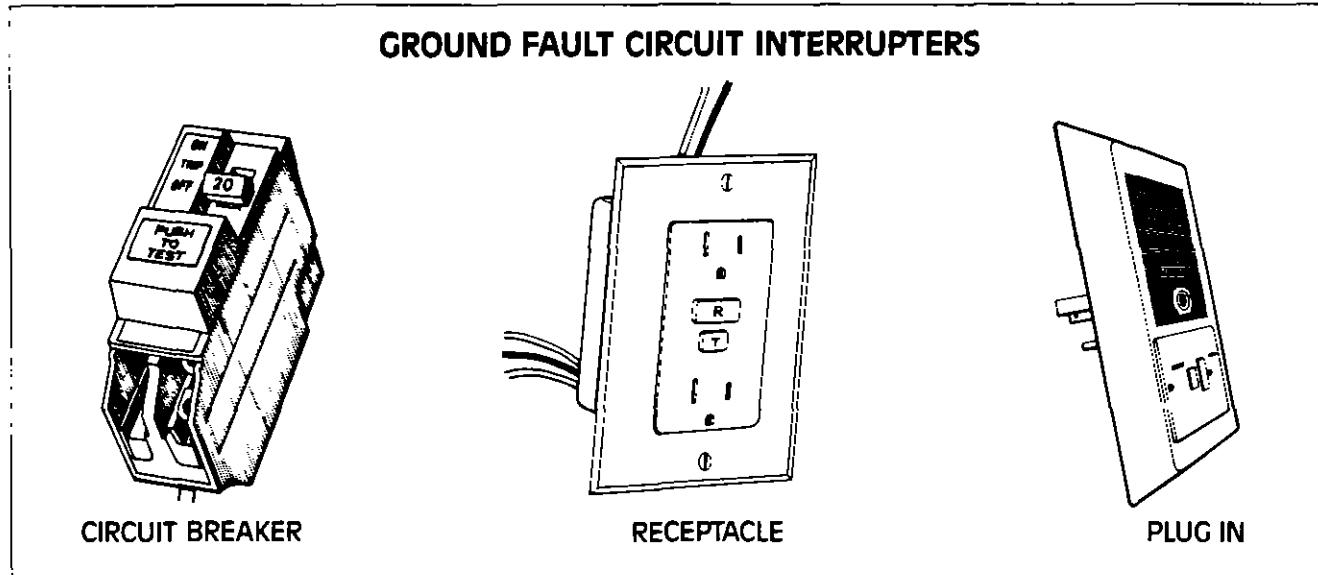

A Ground Fault Circuit Interrupter (GFCI) detects any loss (leakage) of electrical current in this circuit that might be flowing through a person. When such a loss is detected, the GFCI turns electricity off before severe injuries or electrocution can occur. (However, you may receive a painful shock during the time that it takes for the GFCI to cut off the electricity.)

Test the GFCI once a month. To check the unit, press the TEST button. The GFCI should indicate open or off and should disconnect the power from the GFCI protected circuit. Press the RESET switch to restore power.

GFCI receptacle outlets can be installed in place of standard receptacle outlets to protect against electrocution for just that receptacle outlet or a series of receptacle outlets in the same branch.

A GFCI Circuit Breaker can be installed on some circuit breaker electrical panels to protect against electrocution, excessive leakage current, and overcurrent for an entire branch circuit.

Plug-in GFCIs can be plugged into receptacle outlets where appliances will be used.

PROBLEM Electric shocks can be more serious in certain locations of the home, such as bathrooms, kitchens, basements and garages where people can contact heating radiators, water pipes, electric heaters, electric stoves, and water in sinks and bathtubs. If a person touches one of these and a faulty electrical appliance, they can receive a shock and may be electrocuted.

WHAT TO DO:

If you have a home without GFCIs, consult with a qualified electrician about adding this protection.

If you want to install some GFCI protection yourself, use plug-in units to protect individual receptacle outlets. Both two-conductor and three-conductor receptacle outlets can be protected with plug-in units.

You may have a newer home that is equipped with GFCIs in the areas mentioned above.

HOME WIRING PROTECTORS

Warning: Fire

Preventing Home Fires: AFCIs

Problems in home wiring, like arcing and sparking, are associated with more than 40,000 home fires each year. These fires claim over 350 lives and injure 1,400 victims annually.

A new electrical safety device for homes, called an arc fault circuit interrupter or AFCI, is expected to provide enhanced protection from fires resulting from these unsafe home wiring conditions.

Typical household fuses and circuit breakers do not respond to early arcing and sparking conditions in home wiring. By the time a fuse or circuit breaker opens a circuit to defuse these conditions, a fire may already have begun.

Several years ago, a CPSC study identified arc fault detection as a promising new technology. Since then, CPSC electrical engineers have tested the new AFCIs on the market and found these products to be effective.

Requiring AFCIs

AFCIs are already recognized for their effectiveness in preventing fires. The most recent edition of the National Electrical Code, the widely-adopted model code for electrical wiring, will require AFCIs for bedroom circuits in new residential construction, effective January 2002.

Future editions of the code, which is updated every three years, could expand coverage.

AFCIs vs. GFCIs

AFCIs should not be confused with ground fault circuit interrupters or GFCIs. The popular GFCI devices are designed to provide protection from the serious consequences of electric shock.

While both AFCIs and GFCIs are important safety devices, they have different functions. AFCIs are intended to address fire hazards; GFCIs address shock hazards. Combination devices that include both AFCI and GFCI protection in one unit will become available soon.

AFCIs can be installed in any 15 or 20-ampere branch circuit in homes today and are currently available as circuit breakers with built-in AFCI features. In the near future, other types of devices with AFCI protection will be available.

Should You Install AFCIs?

You may want to consider adding AFCI protection for both new and existing homes. Older homes with ordinary circuit breakers especially may benefit from the added protection against the arcing faults that can occur in aging wiring systems.

For more information about AFCIs, contact an electrical supply store, an electrician, or the manufacturer of the circuit breakers already installed in your home. Sometimes these components can be replaced with AFCIs in the existing electrical panel box.

Be sure to have a qualified electrician install AFCIs; do not attempt this work yourself. The installation involves working within electrical panel boxes that are usually electrically live, even with the main circuit breakers turned off.

ARC-FAULT CIRCUIT INTERRUPTERS

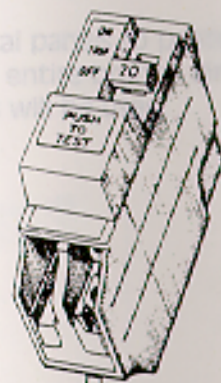

CIRCUIT BREAKER TYPE

To report a product hazard or a product related injury write to the U S Consumer Product Safety Commission Washington D C 20207 In the United States call the toll free hotline 800-638 CPSC (2772) A teletypewriter for the deaf is available on the following numbers National (including Alaska and Hawaii) 800 638 8270 CPSC news releases Public Calendar and other information can be obtained via the Internet from the agency's Web Site [http //www cpsc gov](http://www.cpsc.gov) Agency staff may be contacted by e mail **E mail Address** info@cpsc.gov

This document is in the public domain It may be reproduced in part or in whole by an individual or organization without permission If it is reproduced however the Commission would appreciate knowing how it is used Write the U S Consumer Product Safety Commission Office of information and Public Affairs Washington D C 20207

The U S Consumer Product Safety Commission (CPSC) is an independent regulatory agency charged with reducing unreasonable risks of injury associated with consumer products CPSC is headed by three Commissioners appointed by the President with the advice and consent of the Senate

PRODUCT SAFETY IT S NO ACCIDENT

Regional Centers

U.S Consumer Product Safety Commission Eastern Region

Eastern Regional Center
701 Varck Street Room 903
New York NY 10014 4811
(212) 670 4170

U.S Consumer Product Safety Commission Central Region

Central Regional Center
730 South Dearborn Street Room 2944
Chicago IL 60604 1601
(312) 353 8760

U.S Consumer Product Safety Commission Western Region

Western Regional Center
1301 Clay Street Suite 610 N
Oakland CA 94612
(510) 637 4050

